



Overview

The RBP - Communications Repeater Backplane fits into 2.75" snaptrack (TRK18) and provides power, communications and convenient mounting for the RPTR, FOX and SOX modules.

Connectors on the face of the RBP mate with connectors on the RPTR, FOX and SOX. The RPTR, FOX and SOX share data across the RBP backplane which provides transient protection for the communications network and power connection. Several RBP backplanes can be plugged together to share data and power through the backplane end connectors, allowing all the RPTR, FOX and SOX to form a large communications hub.

The RBP backplane receives 12 VDC power from a 3324VC voltage converter.

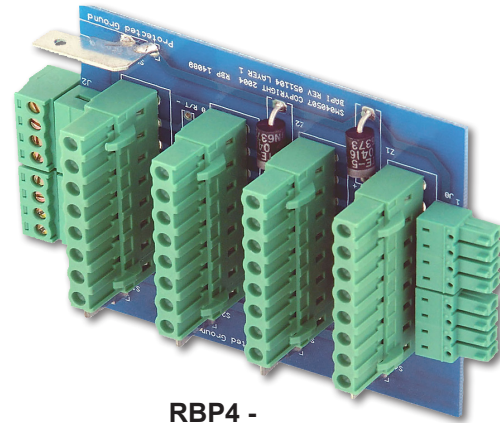

RBP4 - Communications Repeater Backplane

Part Number	Description	List Price
BA/RBP4	Comm. Repeater Backplane, supports 4 communication modules.....	\$90
BA/RBP4-TRK	Comm. Repeater Backplane with 4" piece of 2.75" snaptrack	\$98
BA/RBP8	Comm. Repeater Backplane, supports 8 communication modules.....	\$145
BA/RBP8-TRK	Comm. Repeater Backplane with 6" piece of 2.75" snaptrack	\$155

Submittal datasheets without List Prices are available on our website at www.bapihvac.com

Associated Products

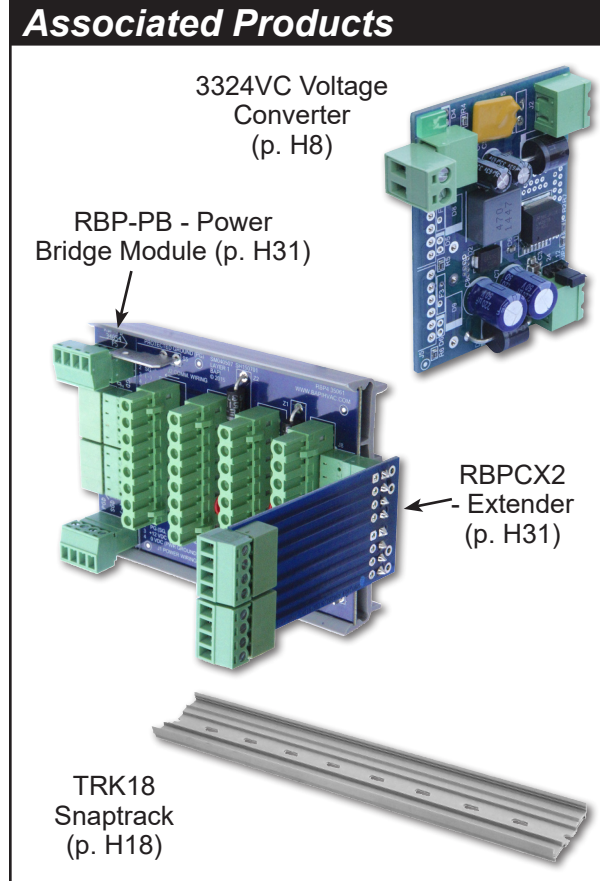

Specifications

